

OPTIONAL LOW-PROFILE WALLMOUNT KIT P/N E721949
 PURCHASED SEPARATELY, CUSTOMER ASSEMBLED

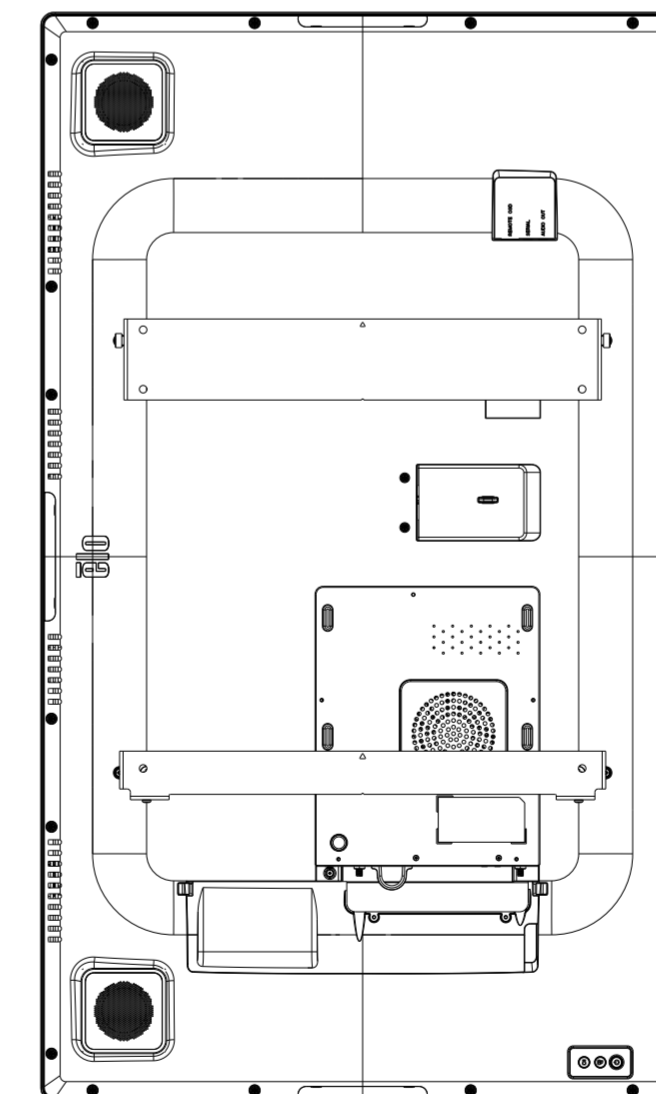

OPTIONAL LOW-PROFILE WALLMOUNT KIT P/N E721949
PURCHASED SEPARATELY, CUSTOMER ASSEMBLED

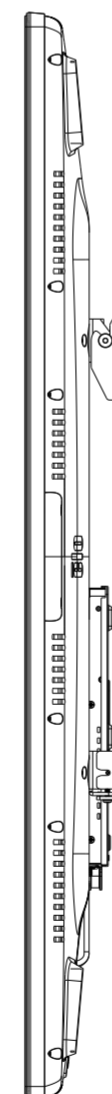
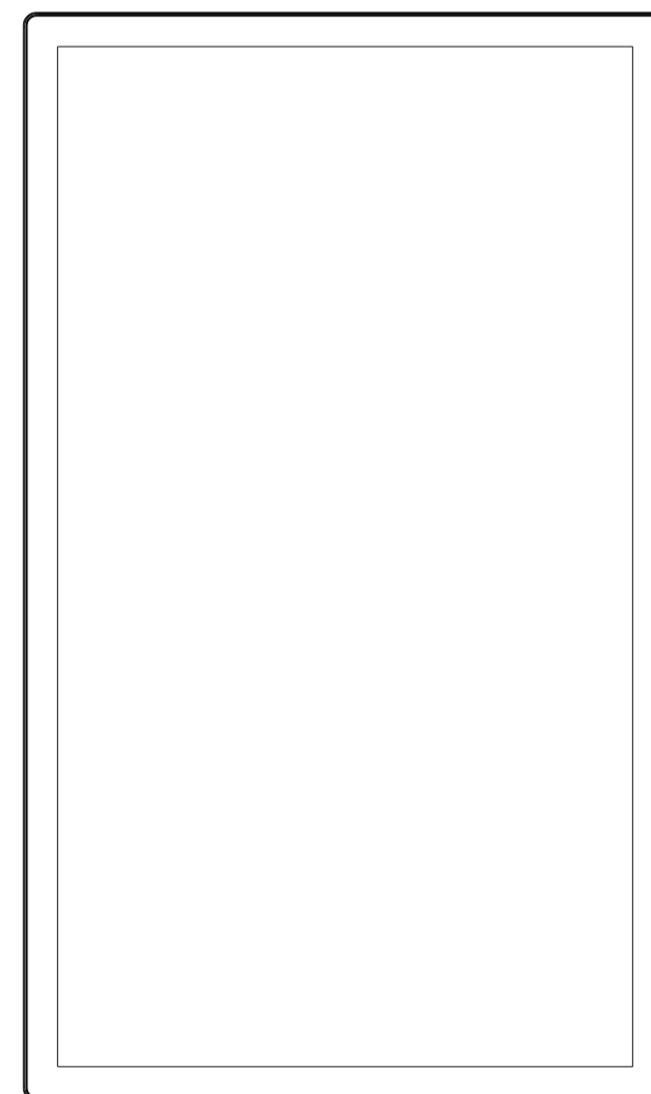
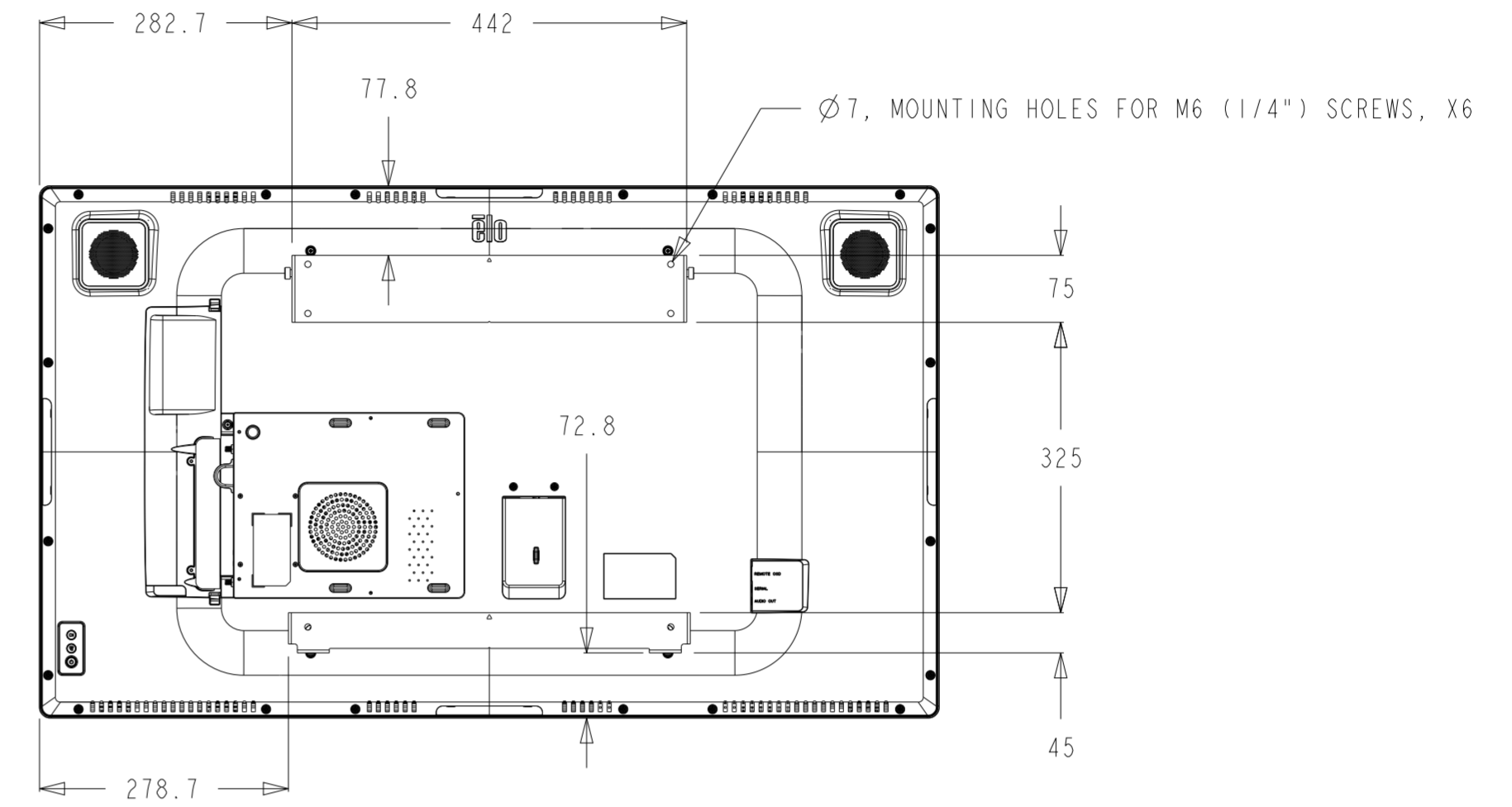
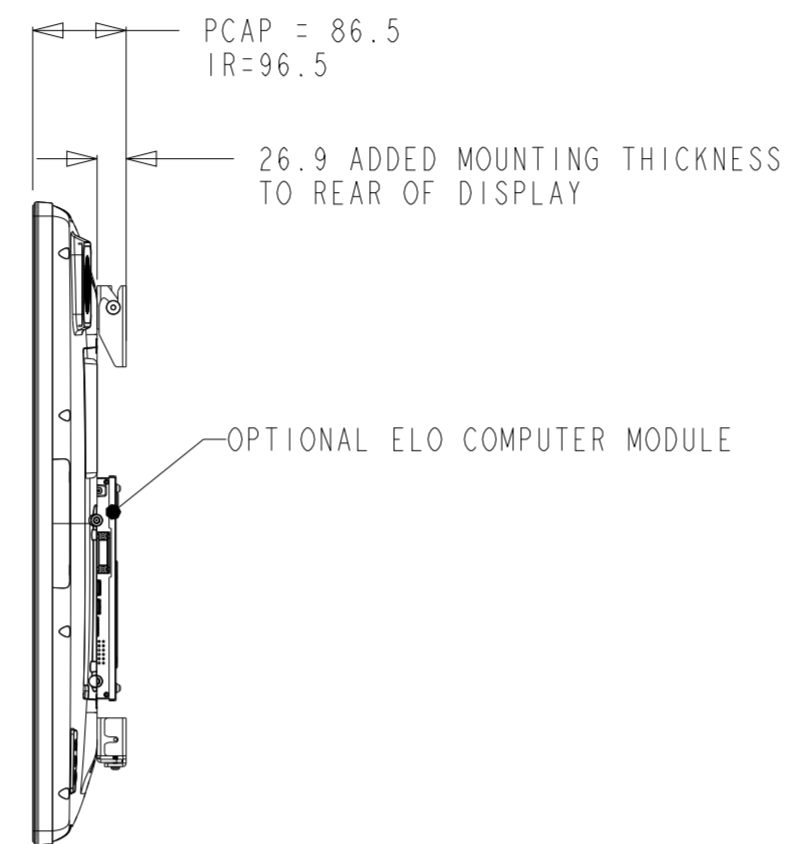
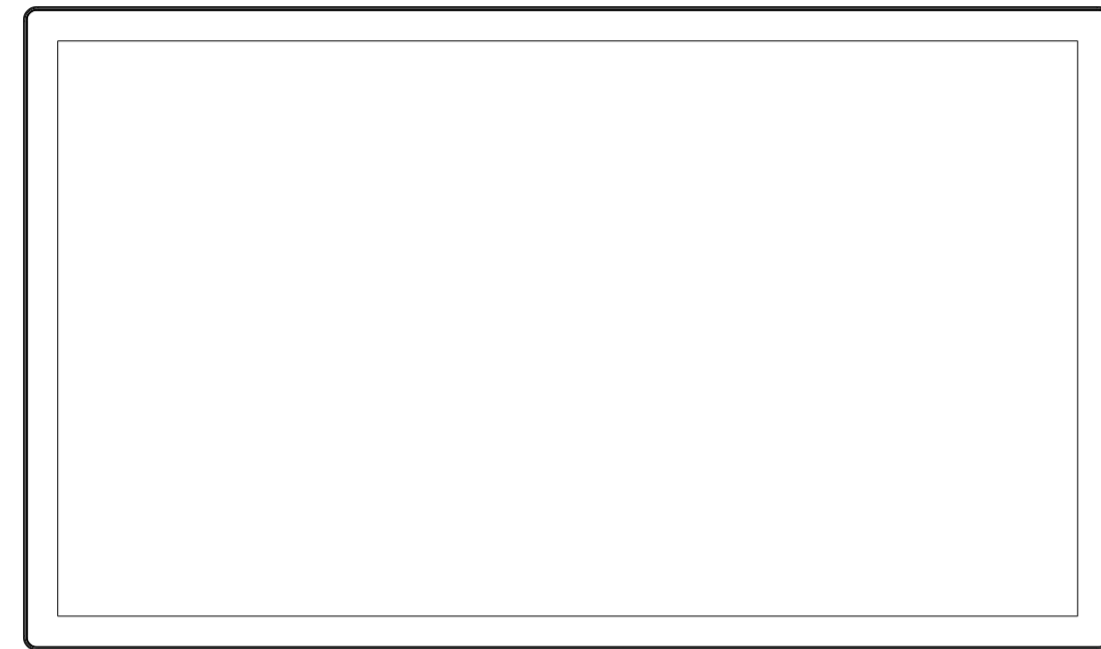
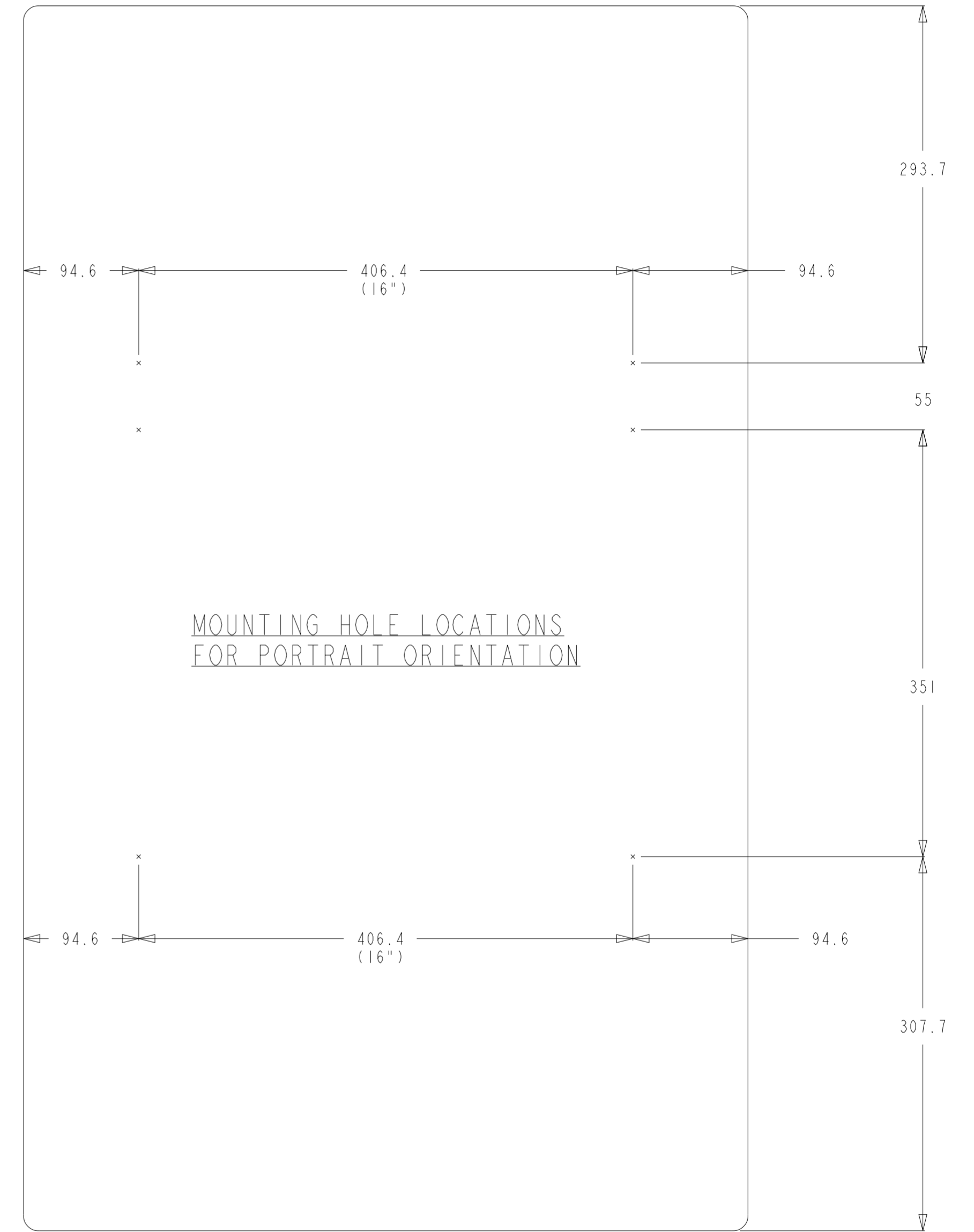
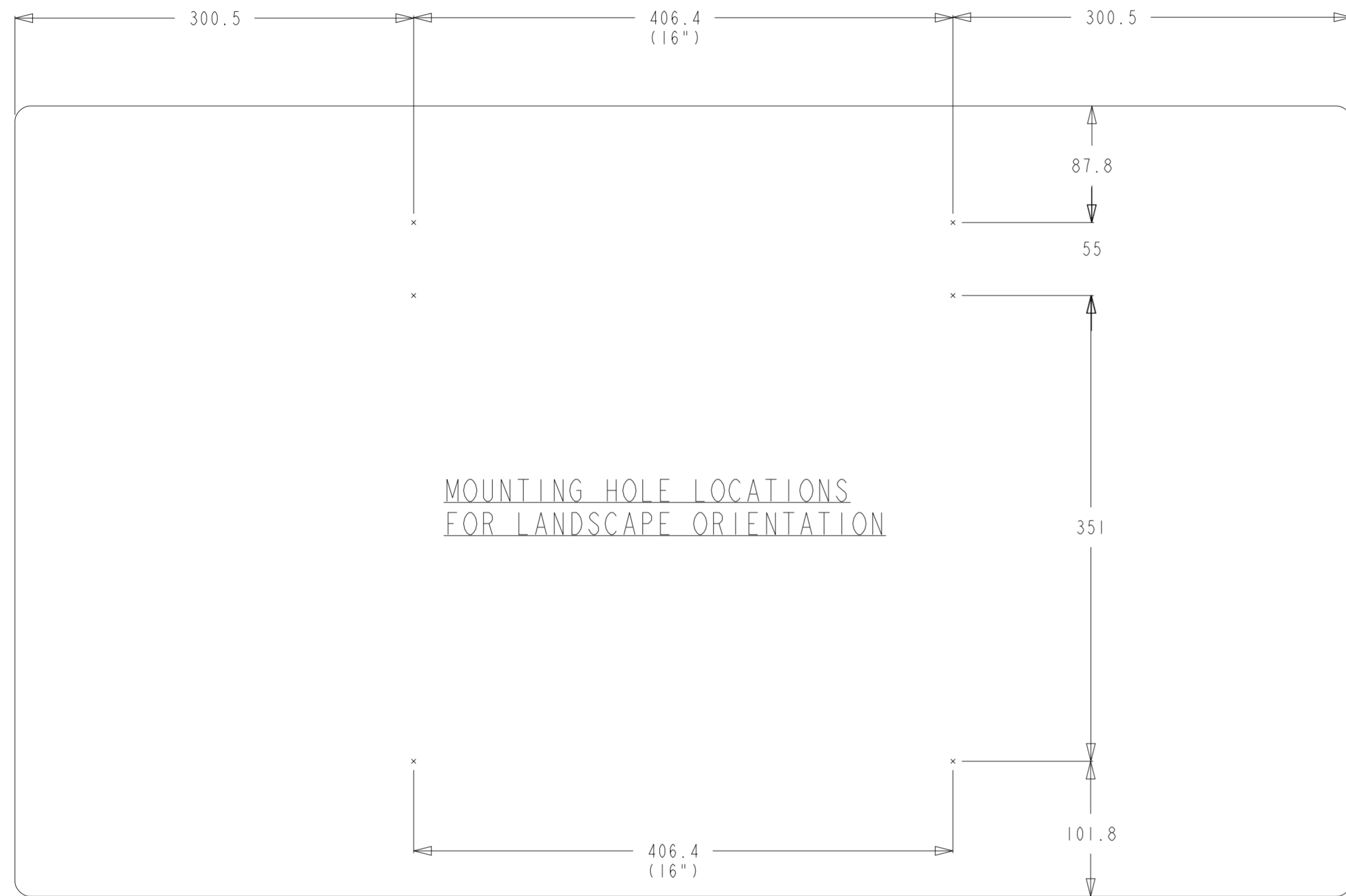

OPTIONAL STAND KIT P/N E722153
PURCHASED SEPARATELY, CUSTOMER ASSEMBLED
NOTE: STAND DOES NOT SUPPORT PORTRAIT ORIENTATION

